



SPORTSBEAMS

SUPERNOVA CHROMABEAMS

**STADIUM-FILLING ADVANCED
THEATRICAL SPORTS LIGHT.**



GLARE-FREE



**BROADCAST
QUALITY**



**NO PLASTIC
LENSES**



**OPTIMAL
THERMAL DESIGN**



**ADVANCED
INTELLIGENCE**



**COLOR TUNABLE
WHITE**



**FULL
PRE-MIXED RGB**

SUPERNOVA CHROMABEAMS

SPORTSBEAMS



KEY FEATURES

- 1450W LED illumination
- 160,000+ lumens tunable white from 1800k - 10000k
- Full-color RGB
- No plastics used in the light path
- DMX 512 controllability to each fixture
- Glare-reducing, patented single glass optic for even field lighting
- High 90+ CRI color fidelity option
- Built-in over temperature protection
- IP-66 weather-tight housing & system
- Patented cooling ensures years of uninterrupted service
- 120,000+ hour rated LEDs
- IP-66 proprietary power supply with surge protection

SPORTSBEAMS

SUPERNOVA CHROMABEAMS

RGB-AW LED Architectural & Sports Lighting Fixture

TYPICAL INSTALLATIONS

- Stadiums
- Scholastic Sports Fields
- Municipal Sports Fields
- Building Wall Washes
- High Mast

MOUNTING OPTIONS

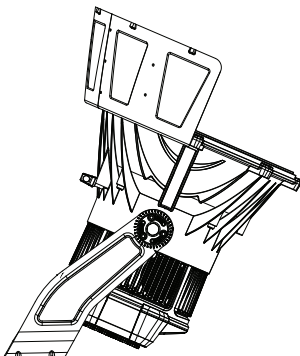

TOP MOUNT UP

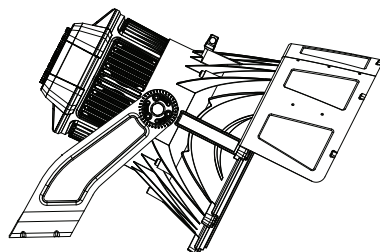

TOP MOUNT DOWN

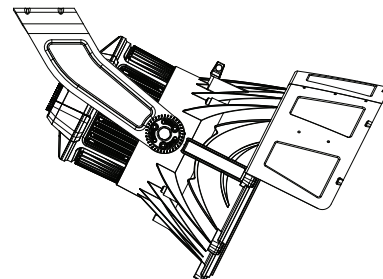

UNDERSLUNG

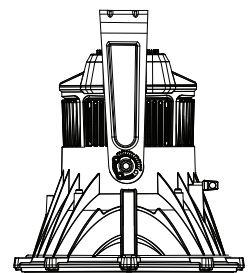

PENDANT MOUNT

DIMENSIONS

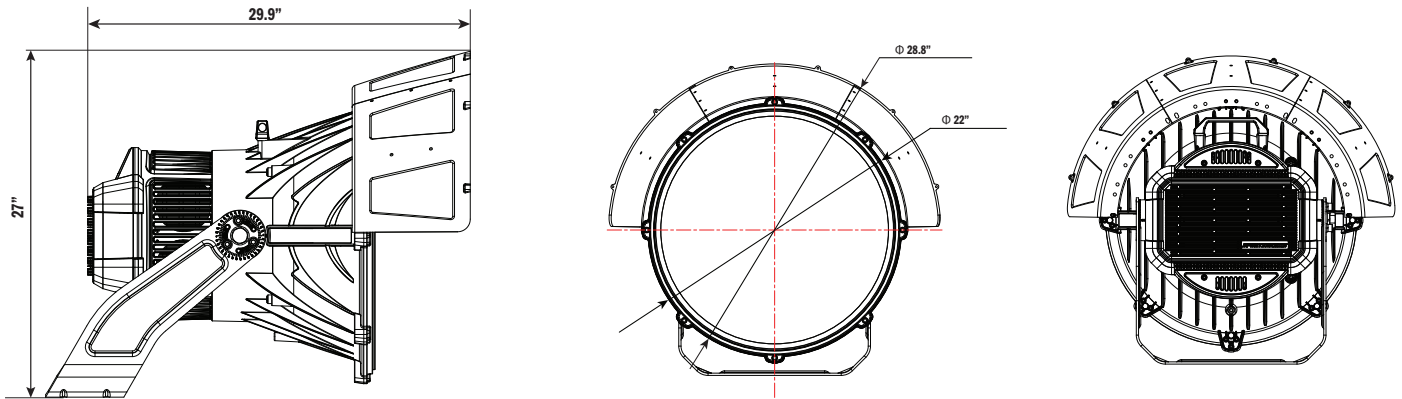

TECHNICAL SPECIFICATIONS¹

LIGHT & OPTICS

LUMEN OUTPUT RANGE	136372 ~ 187500
LUMEN-TO-WATT RANGE	92 ~ 124 lm/W
CRI/TLCI OPTIONS ²	80/80 or 95+/95+
CCT OPTIONS	1800K ~ 10000K
NEMA OPTIONS	3/4/5

ELECTRICAL

SYSTEM POWER	1500W
FREQUENCY RANGE	45~66 Hz
INPUT VOLTAGE	240V ~ 480V
DC VOLTAGE	51V
INPUT CURRENT	5.8A
POWER FACTOR	0.9 @ 277V
THD	<15%
INRUSH CURRENT	<80A
ELECTRICAL CERTIFICATIONS	FCC, CE, ETL, IK08, CB, KC, UL 924
SURGE PROTECTION	L-L 5kV ~ L-PE 10kV
OVER TEMPERATURE PROTECTION	AUTOMATIC RECOVERY
OVER VOLTAGE PROTECTION	RECOVERY AFTER POWER CYCLE
OVER LOAD PROTECTION:	AUTOMATIC RECOVERY

CONSTRUCTION

OPERATING TEMPERATURE RANGE ³	-50°C to +50°C
USAGE ENVIRONMENTS	INDOOR, OUTDOOR
MOUNTING OPTIONS	PEDESTAL, PENDANT
ENVIRONMENTAL CERTIFICATIONS	ROHS, FCC, SALT SPRAY (MIL-STD-810)
EFFECTIVE PROJECTED AREA (EPA)	3.59(ft ²) WITH OR WITHOUT VISOR
APPROXIMATE WEIGHT ⁴	75lbs

NOTES

(1) Specifications are subject to change without notice
 (2) Values are +/- 5%

(3) Values are +/- 4% when fixture is operated at 25°C ambient
 (4) Weight may vary depending on mounting bracket

WHITE LUMEN CHART

NEMA	TEMP	CRI	LUMENS
2	4000K	75	181,875
2	5000K	75	181,875
2	5700K	75	181,875
2	4000K	90	151,056
2	5000K	90	151,056
2	5700K	90	151,056
3	4000K	75	187,500
3	5000K	75	187,500
3	5700K	75	187,500
3	4000K	90	155,727
3	5000K	90	155,727
3	5700K	90	155,727
4	4000K	75	179,469
4	5000K	75	179,469
4	5700K	75	179,469
4	4000K	90	149,058
4	5000K	90	149,058
4	5700K	90	149,058
5	4000K	75	164,195
5	5000K	75	164,195
5	5700K	75	164,195
5	4000K	90	136,372
5	5000K	90	136,372
5	5700K	90	136,372

RGB LUMEN CHART

COLOR	LUMENS
RED	14,015
GREEN	14,951
BLUE	9,905

COLOR RENDERING INDEX RESULTS

IES TM-30-18 COLOR RENDITION REPORT @4000K CRI 95+

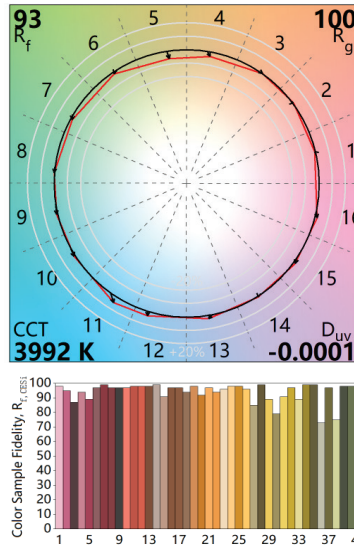
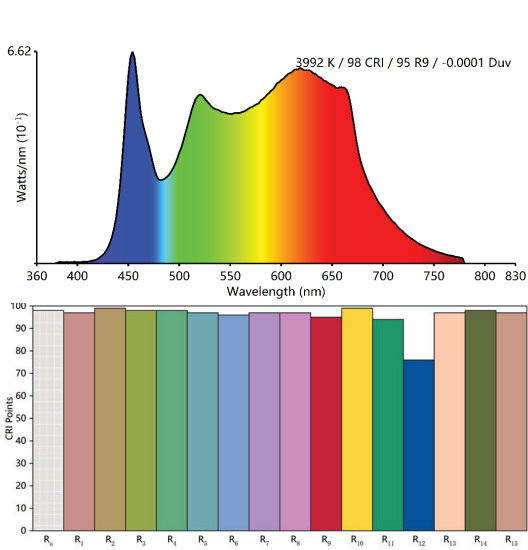

Direct spectrum input : CCT = M3992 (0.0)
TLCI-2012 : 98 (M3992)



IES TM-30-18 COLOR RENDITION REPORT @5600K CRI 95+

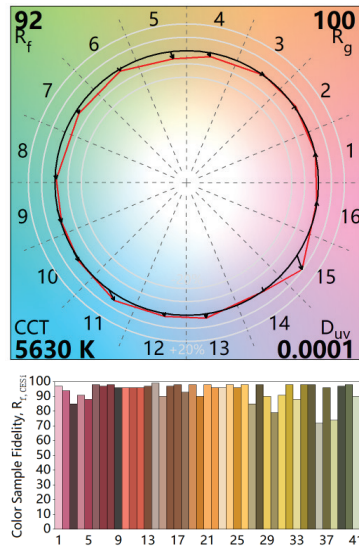
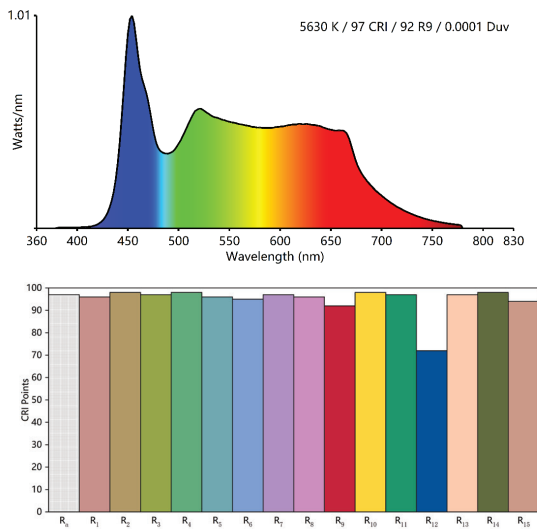

Direct spectrum input : CCT = D5630 (-0.6)
TLCI-2012 : 98 (D5630)



