



**SPORTSBEAMS**

# NOVA

COST-COMPETITIVE BROADCAST  
LIGHT DESIGNED TO LAST FOR YEARS



GLARE-FREE



BROADCAST  
QUALITY



NO PLASTIC  
LENSES



OPTIMAL  
THERMAL DESIGN



ADVANCED  
INTELLIGENCE



## KEY FEATURES

- 1000W LED illumination
- Up to 138,000+ lumens
- No plastics used in the light path
- DMX controllability to each fixture
- Glare-reducing, patented single glass optic for even field lighting
- High 90+ CRI color fidelity option
- Built-in over temperature protection
- IP-66 weather-tight housing & system
- Patented cooling ensures years of uninterrupted service
- 120,000+ hour rated LEDs
- IP-67 proprietary power supply with surge protection

SPORTSBEAMS

## NOVA

White LED Sports & Architectural Lighting Fixture

## TYPICAL INSTALLATIONS

- Stadiums
- Scholastic Sports Fields
- Arenas and Auditoriums
- Convention Center Halls
- Building Wall Washes
- High Mast

## MOUNTING OPTIONS

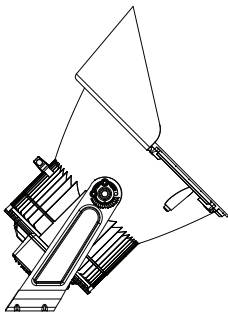

TOP MOUNT UP

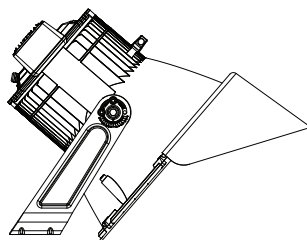

TOP MOUNT DOWN

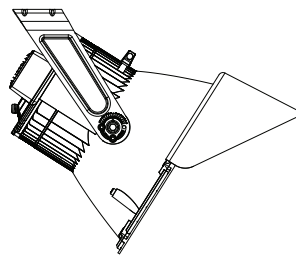

UNDERSLUNG

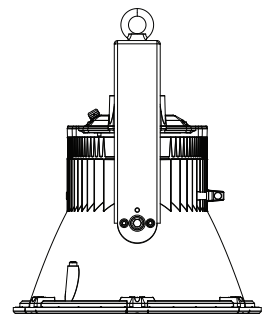

PENDANT MOUNT

## DIMENSIONS

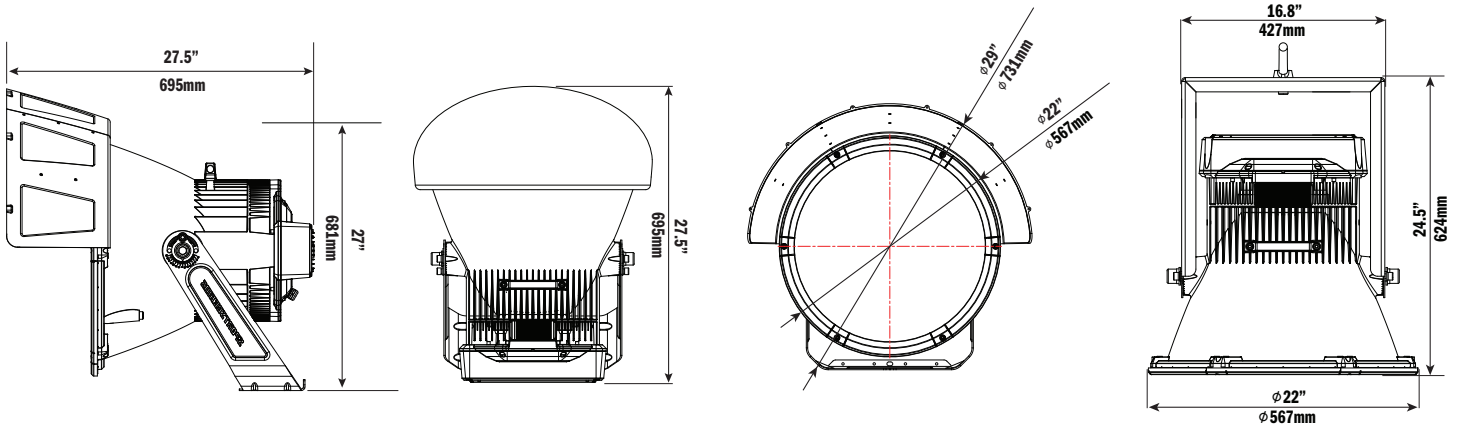

## TECHNICAL SPECIFICATIONS<sup>1</sup>

### LIGHT & OPTICS

LUMEN OUTPUT RANGE	91582 ~ 136138
LUMEN-TO-WATT RANGE	91 ~ 139 lm/w
CRI/TLCI OPTIONS <sup>2</sup>	75/75 or 90/85
CCT OPTIONS	2700K ~ 5700K
NEMA OPTIONS	2/3/4/5/7

### ELECTRICAL

SYSTEM POWER <sup>3</sup>	1000W
FREQUENCY RANGE	45~66 Hz
INPUT VOLTAGE	240V ~ 480V
DC VOLTAGE	51V
CURRENT RANGE	3.75A Max @ 277V, 2.1A Max @ 480V
POWER FACTOR	0.95 @ 277V
THD	<20%
INRUSH CURRENT	<35A
ELECTRICAL CERTIFICATIONS	FCC, CE, ETL, IK08, CB, SAA, UL 924
SURGE PROTECTION	L-N 6kV ~ L-N-PE 10kV
OVER TEMPERATURE PROTECTION	AUTOMATIC RECOVERY
OVER VOLTAGE PROTECTION	RECOVERY AFTER POWER CYCLE
OVER LOAD PROTECTION:	AUTOMATIC RECOVERY

### CONSTRUCTION

OPERATING TEMPERATURE RANGE	-40°C to +50°C
USAGE ENVIRONMENTS	INDOOR, OUTDOOR
MOUNTING OPTIONS	PEDESTAL, PENDANT
ENVIRONMENTAL CERTIFICATIONS	ROHS, FCC, SALT SPRAY (MIL-STD-810)
VIBRATION	ANSI C136.31-2010 3G
EFFECTIVE PROJECTED AREA (EPA)	3.14(ft <sup>2</sup> ) WITH OR WITHOUT VISOR
APPROXIMATE WEIGHT <sup>4</sup>	48.5lbs

### NOTES

(1) Specifications are subject to change without notice  
 (2) Values are +/- 5%

(3) Values are +/- 4% when fixture is operated at 25°C ambient  
 (4) Weight may vary depending on mounting bracket

## LUMEN CHART

NEMA	TEMP	CRI	LUMENS
2	4000K	75	136,138
2	5000K	75	136,138
2	5700K	75	134,173
2	4000K	90	112,504
2	5000K	90	112,504
2	5700K	90	112,504
3	4000K	75	138,526
3	5000K	75	138,526
3	5700K	75	136,421
3	4000K	90	114,477
3	5000K	90	114,477
3	5700K	90	114,477
4	4000K	75	134,550
4	5000K	75	134,550
4	5700K	75	132,506
4	4000K	90	111,192
4	5000K	90	111,192
4	5700K	90	111,192
5	4000K	75	121,739
5	5000K	75	121,739
5	5700K	75	119,890
5	4000K	90	100,605
5	5000K	90	100,605
5	5700K	90	100,605
7	4000K	75	110,821
7	5000K	75	110,821
7	5700K	75	109,137
7	4000K	90	91,582
7	5000K	90	91,582
7	5700K	90	91,582

### MONO WITHOUT VISOR

## ORDERING MATRIX

FAMILY	MODEL	TECHNOLOGY	NEMA TYPE	NATIVE CCT	CRI	MOUNT	FINISH
<b>NOVA</b>	<b>N</b>	<b>M</b>	<b>4</b>	<b>5000</b>	<b>95</b>	<b>S</b>	<b>G</b>

**O** = Orbit    **N** = Nova    **M** = MONO    **2** = 2H x 2V    **3000** = 3000K    **80** = 80 CRI    **S** = Standard    **G** = Gray  
**C** = Comet    **S** = Super    **C** = CHROMA    **3** = 3H x 3V    **4000** = 4000K    **95** = 95CRI    **P** = Pendant    **B** = Black  
**P** = Pulsar    **U** = Ultra       **4** = 4H x 4V    **5000** = 5000K                                           **W** = White  
**N** = Nova                      **5** = 5H x 5V    **5700** = 5700K

**MOST COMMON SKU**  
N-M-1-5000-95-S-G

(1) Any colors other than our standard gray can incur extra costs and increased lead time

### FIXTURE BASE YOKE

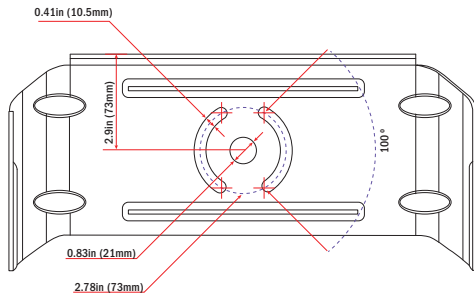

### CATWALK MOUNT

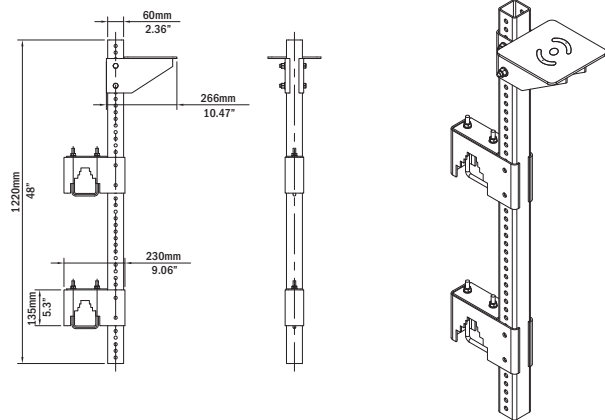

### RETROFIT CROSSARM PLATE

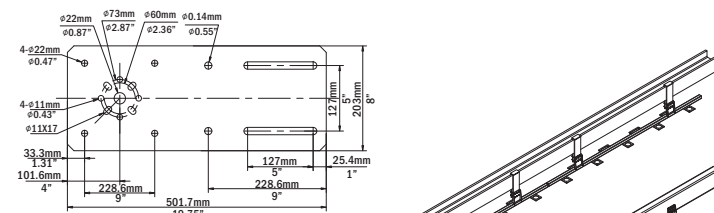
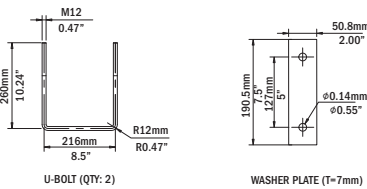

### STANDARD I-BEAM MOUNT

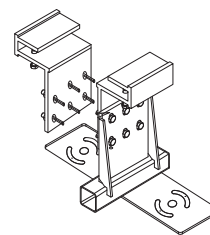

### HORIZONTAL I-BEAM MOUNT

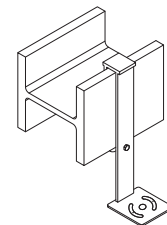

### HORIZONTAL I-BEAM MOUNT

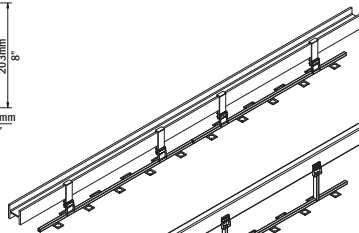

### RECTANGULAR BEAM MOUNT

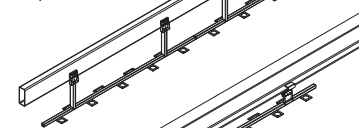

### I-BEAM MOUNT

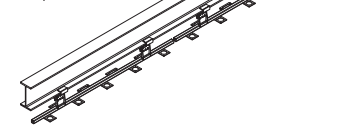

### 3-FIXTURE CROSS ARM FOR POLE

